

# 2.4GHz/5GHz Diplexer with/without LTE Coexistence Filter-SMA Output

Model: SMA-DP-LTE / SMA-DP

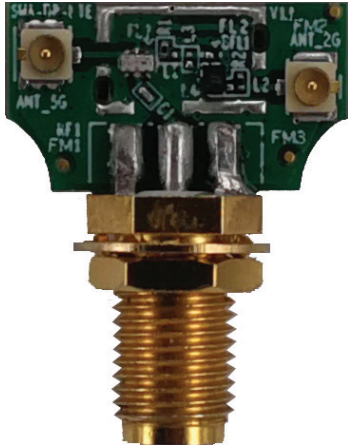

## KEY FEATURES

- Combine the 2.4GHz and 5GHz signals to one single dual-band antenna
- LTE coexistence option are with High Rejection in LTE bands especially B7/B30/B40 and B41
- Low insertion loss <1.3dB

## APPLICATIONS

- WiFi bandpass filter that enables the coexistence of LTE and WiFi/Bluetooth signals
- WiFi or LTE Gateways, Routers, and Set-top boxes
- WiFi Access Points

## Specifications

Description	Diplexer interface board (U.FL to SMA)
Host Interface	1x1 2.4GHz U.FL connector 1x1 5GHz U.FL connector 1x1 2.4/5GHz SMA connector
Dual Band	Yes
Frequency Range	2412MHz~2472MHz 4900MHz~5950MHz
Insertion Loss	SMA-DP-LTE 2412MHz~2472MHz: 1.2dB 4900MHz~5950MHz: 1.2dB  SMA-DP 2412MHz~2472MHz: 0.9dB 4900MHz~5950MHz: 1.3dB
VSWR	SMA-DP-LTE 2412MHz~2472MHz: 1.6:1 4900MHz~5950MHz: 1.6:1  SMA-DP 2412MHz~2472MHz: 1.2:1 4900MHz~5950MHz: 1.6:1
Humidity	Operating: 5% to 95% (non-condensing) Storage: Max. 90% (non-condensing)
Temperature Range	Operating: -20°C to 70°C Storage: -40°C to 90°C
Impedance	50 Ω
Dimension (W x H x D)	23mm x18 mm x10mm

# Mechanical Dimensions

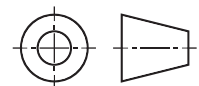
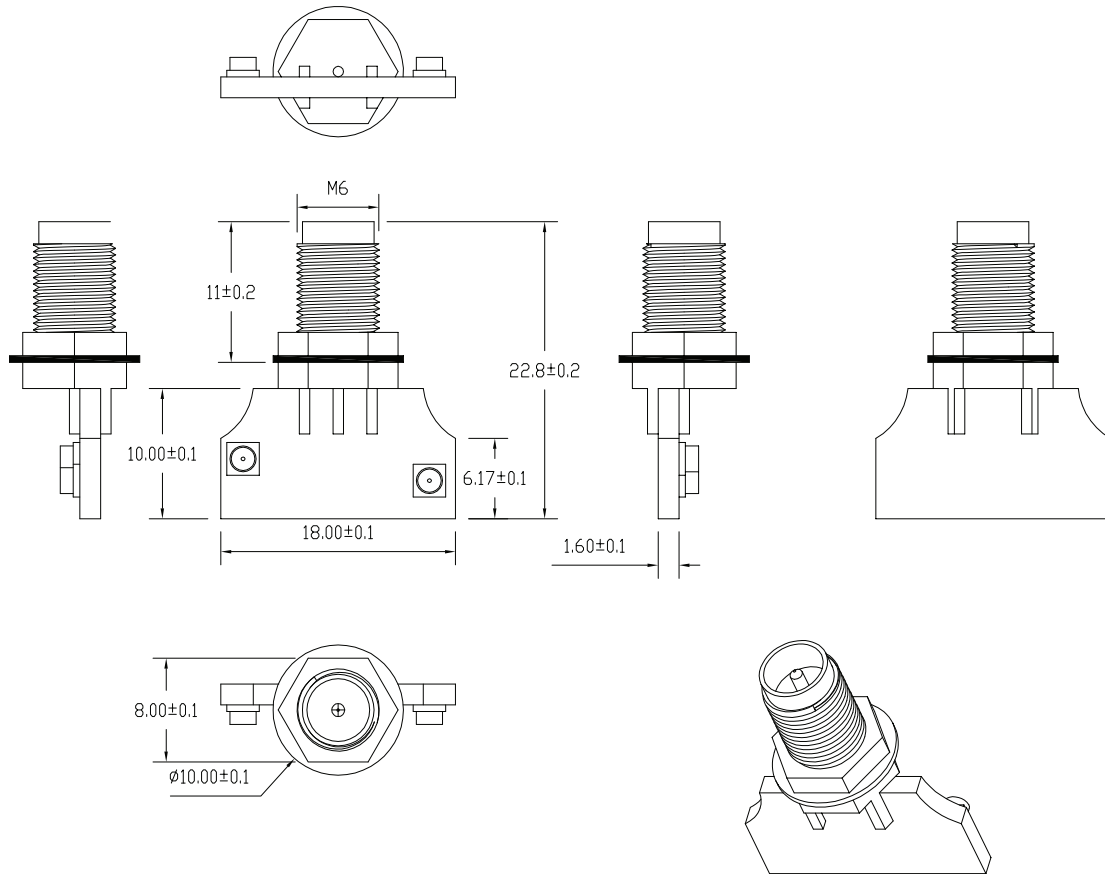

All dimensions are in mm.

## Configuration Example: 4x4 5GHz + 4x4 2.4GHz AP

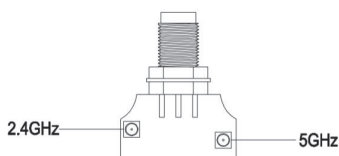
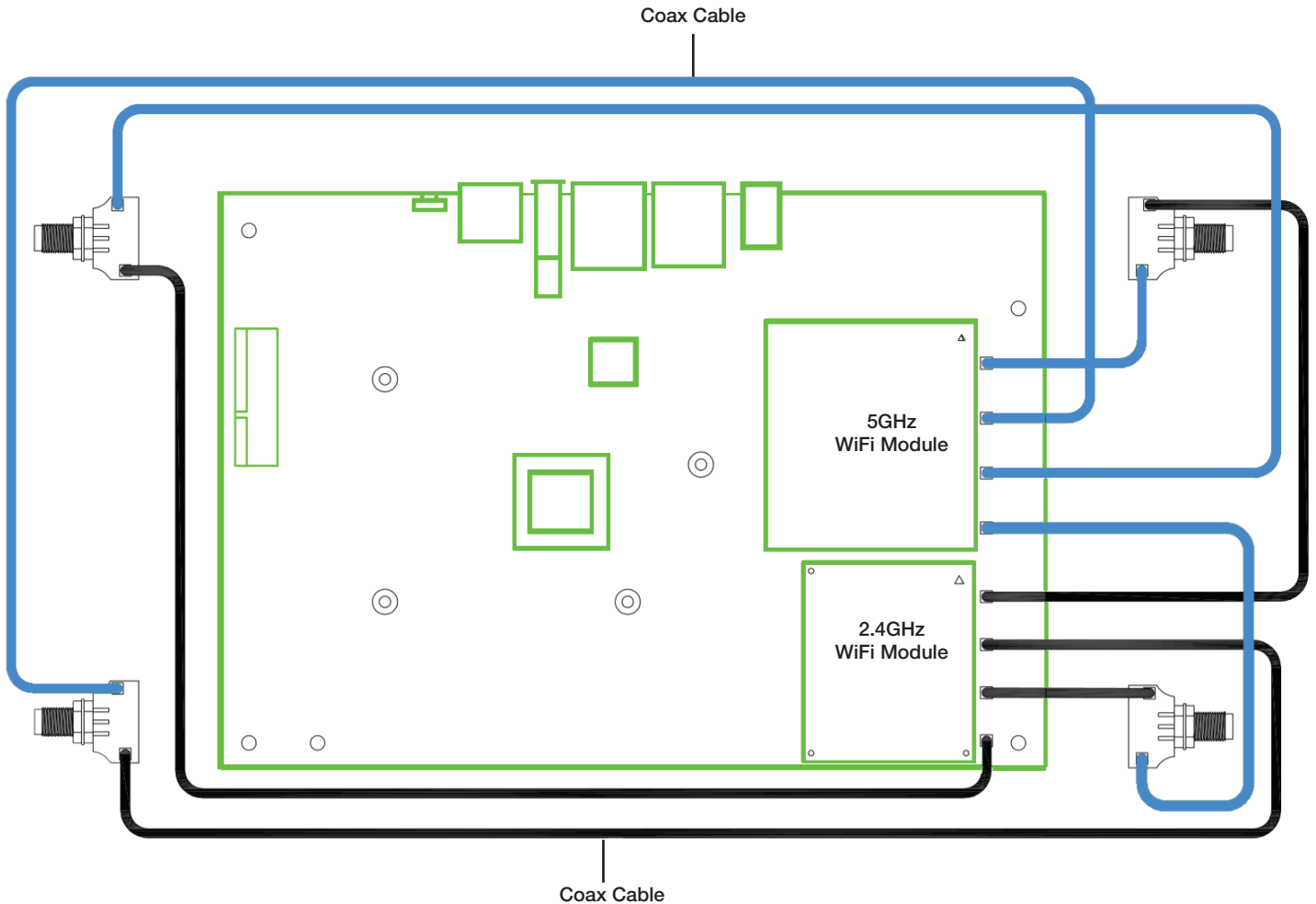

**NOTE:**

This illustration drawing is based on an embedded board that supports both 4x4 2.4GHz and 5GHz WiFi radio. Instead of using 8x Antennas for both WiFi radio, you may now reduce the antenna to 4 by using our diplexer to connect both 2.4GHz and 5GHz radios together.

# Component Maps

## Diplexer With LTE Coexistence Filter

### SMA-DP-LTE

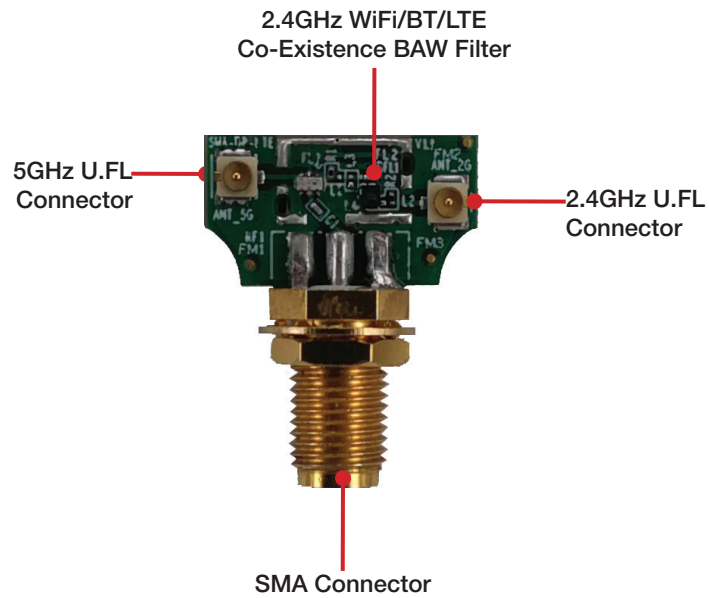

## Diplexer Without LTE Coexistence Filter

### SMA-DP

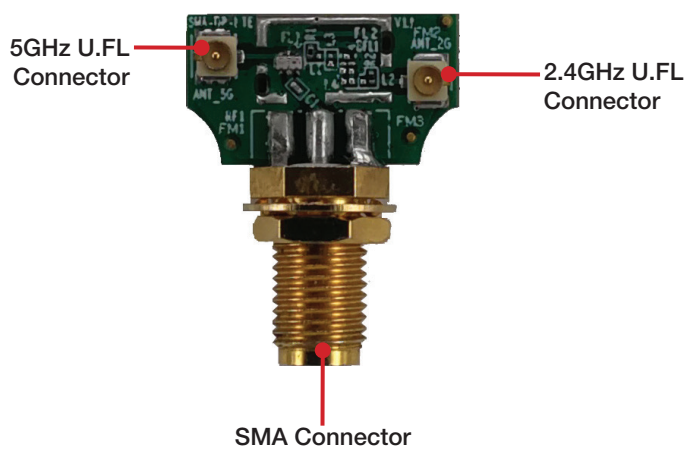

# Performance Test Result

Test conditions unless otherwise noted: Temp. = +25°C

SMA-DP-LTE

S21 Port 2.4GHz

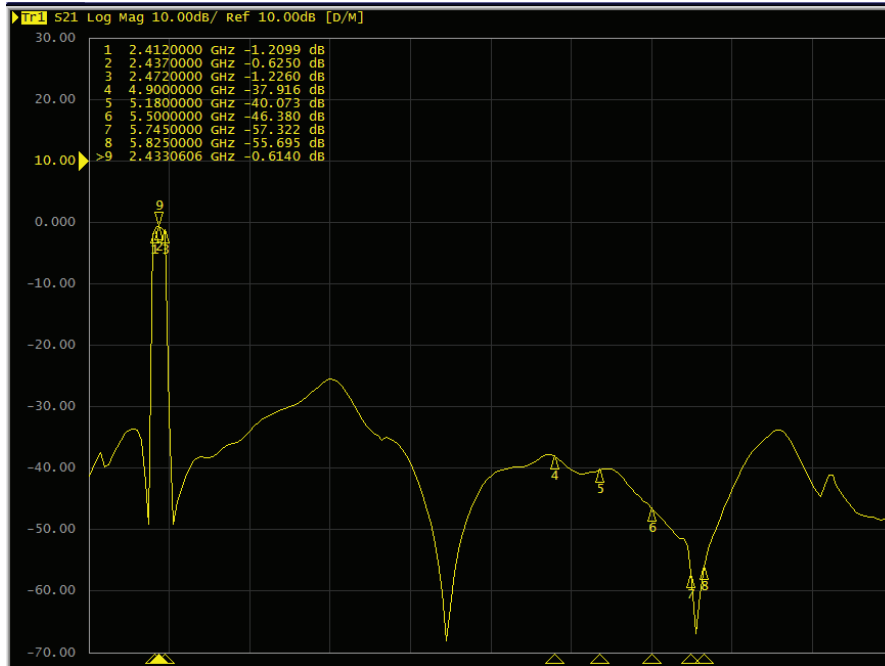

S11 Port 2.4GHz

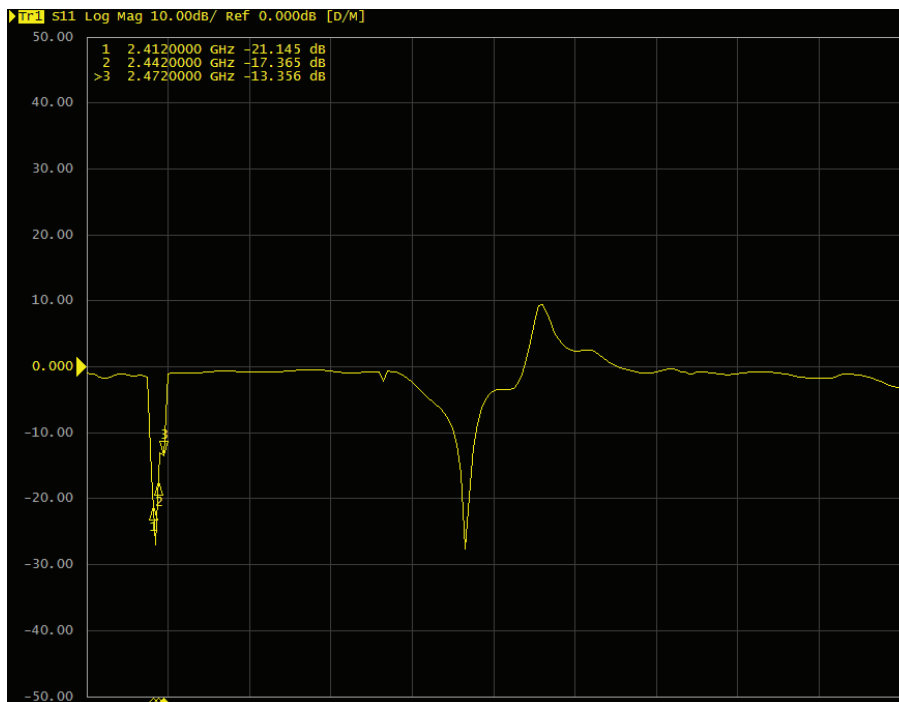

# Performance Test Result

Test conditions unless otherwise noted: Temp. = +25°C

SMA-DP-LTE

S21 Port 5GHz

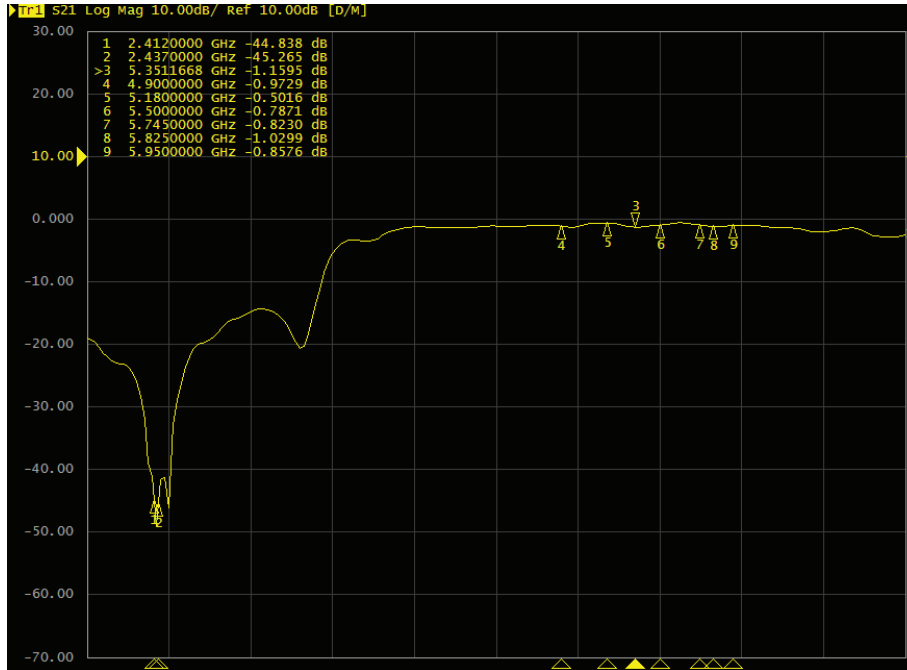

S11 Port 5GHz

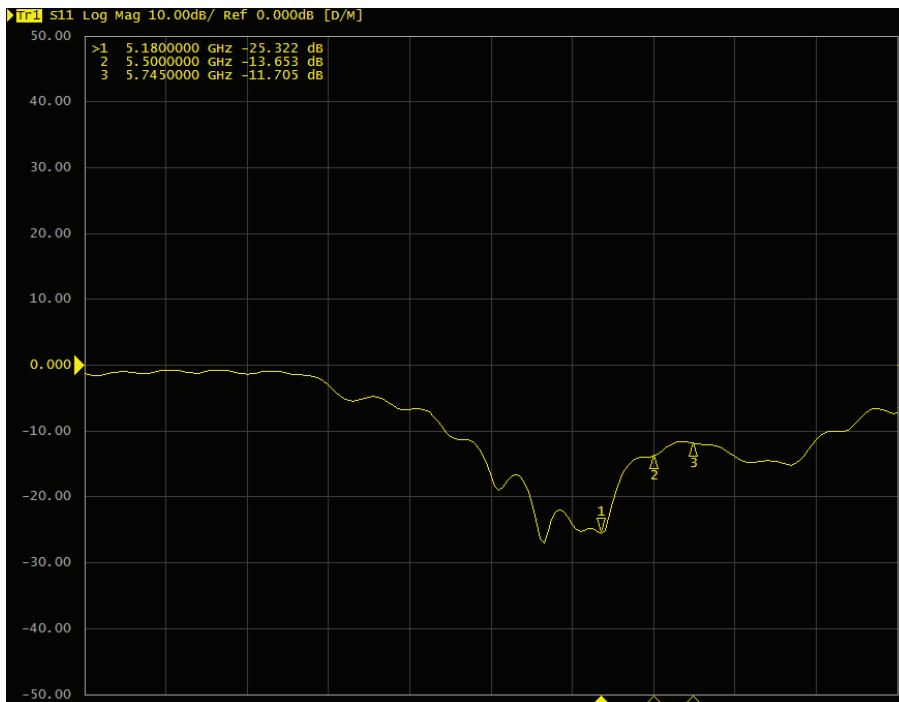

# Performance Test Result

Test conditions unless otherwise noted: Temp. = +25°C

SMA-DP

S21 Port 2.4GHz

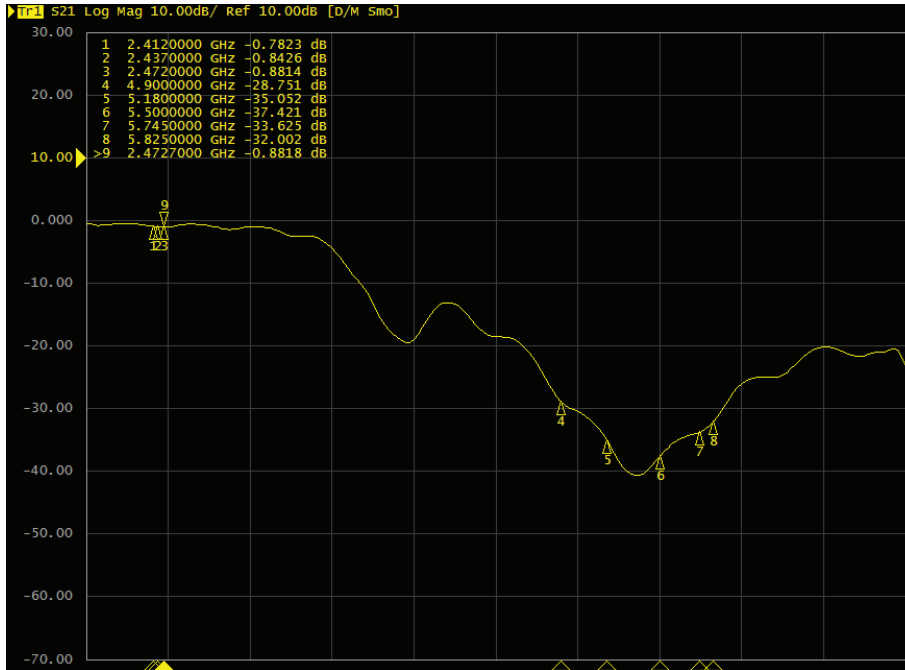

S11 Port 2.4GHz

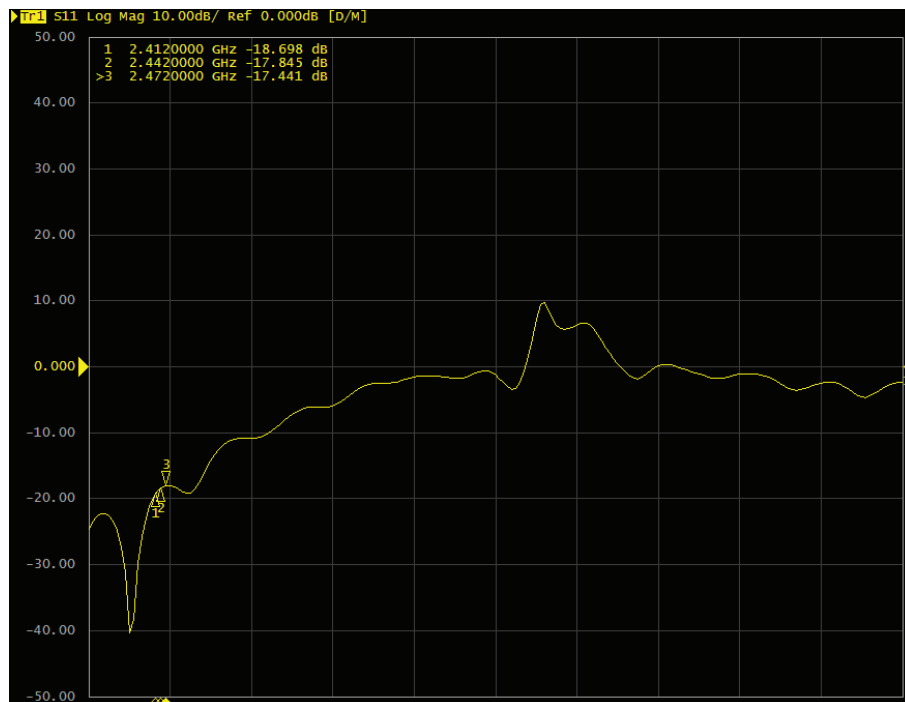

# Performance Test Result

Test conditions unless otherwise noted: Temp. = +25°C

SMA-DP

S21 Port 5GHz

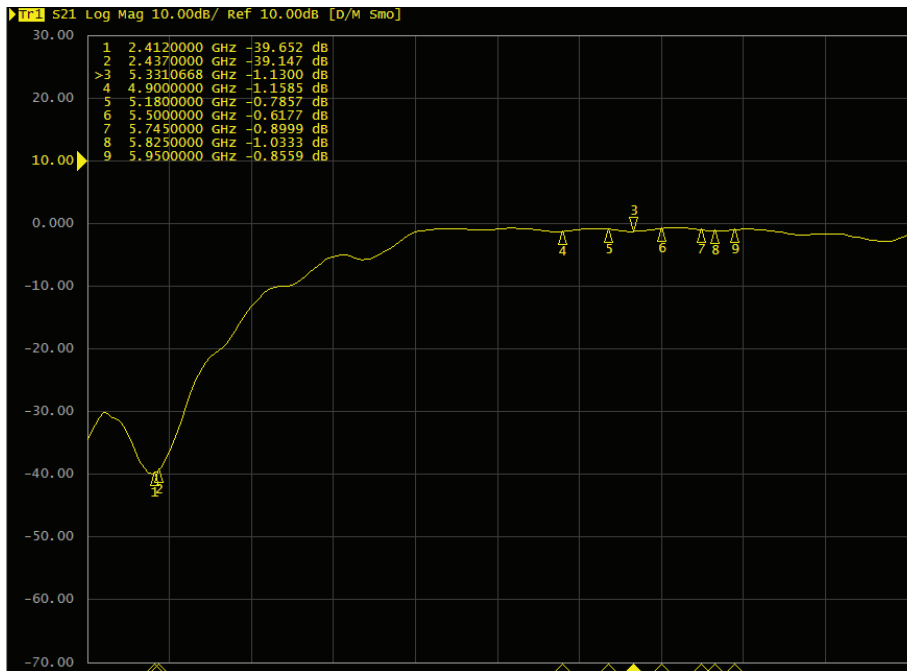

S11 Port 5GHz

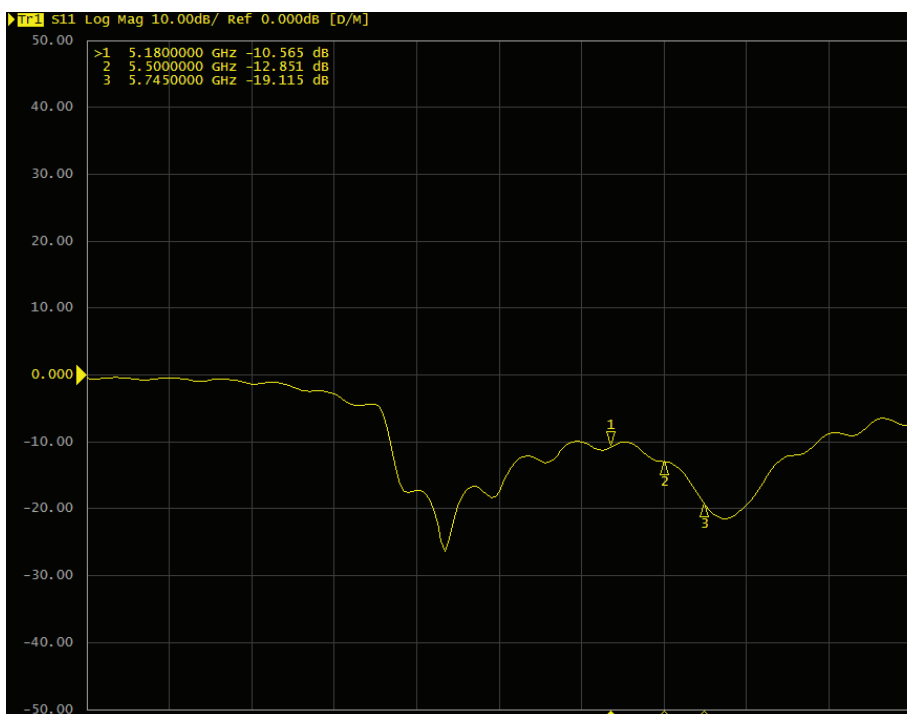



## Ordering Options

Item Code	Model	Description
P-SMA-DP-LTE V1.2	SMA-DP-LTE	With LTE Filter
P-SMA-DP V1.2	SMA-DP	Without LTE Filter