

Outdoor Enclosure with 2.4GHz 11dBi Panel Antenna



Model: MJE-2.4N11

KEY FEATURES

- Weatherproof IP53 Enclosure
- 11dBi Long Distance Antenna

APPLICATIONS

- Outdoor Long Distance Point-to-Point (PtP) AP
- Point-to-MultiPoint (PtMP) AP
- Outdoor Mesh AP



Enclosure Specifications

Material	ABS/PC, Flame Retardant, UV resistant
Color	White
Weight	0.5kg
Outside Dimensions (H x W x D)	278.5mm x 122.2mm x 94.5mm
Integrated Antenna	2.4GHz 11dBi panel antenna
Ethernet Interface	RJ45
Casing	Weatherproof Structure
Rating of Enclosure	IP53
Mounting	Pole Mount or Wall Mount

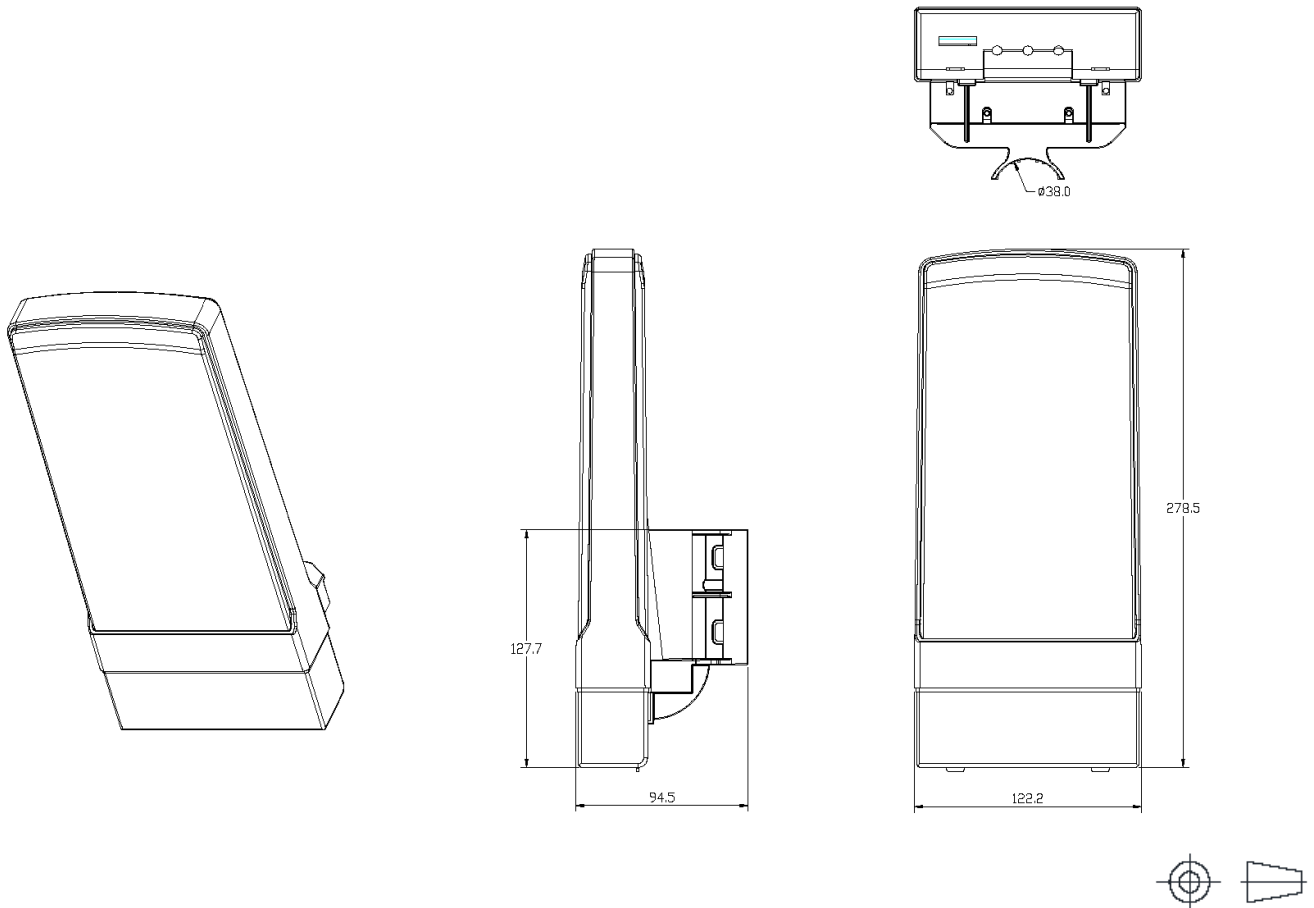
Dimensional Drawing

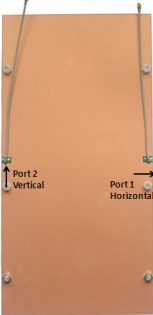

Features and Illustrations

Features	Illustrations
<p>Antenna Port Orientation</p>	
<p>Mounting</p>	

Antenna Element Specifications

Gain	11dBi
Radiation	Directional
Connectors	2x U.FL or MMCX Antenna Connectors
Frequency Range	2.3 ~ 2.5 GHz
Polarization	Dual Polarization
Azimuth -3dB Beamwidth	Horizontal (Port 1) : 56 degrees Vertical (Port 2) : 62 degrees
Elevation -3dB Beamwidth	Horizontal (Port 1) : 38 degrees Vertical (Port 2) : 26 degrees

Antenna Element Specifications

Isolation	30dB (Min)
Front-to-Back Ratio	24dB (Min)
VSWR	Horizontal (Port 1) : < 1.97:1 Vertical (Port 2) : < 1.67:1
Cross Polarization Isolation	30dB (Min)
SideLobe	< -12dB

Gain Plot

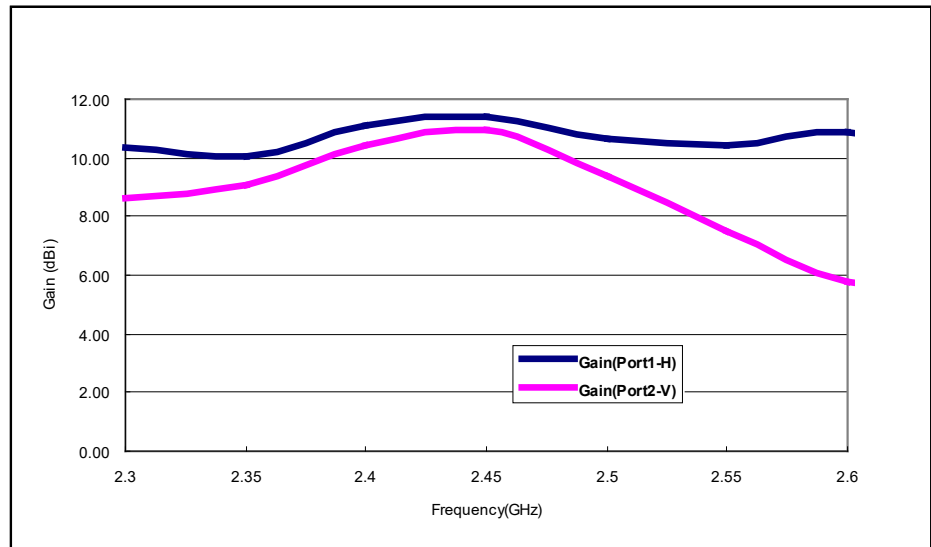

Return Loss and Isolation Plot

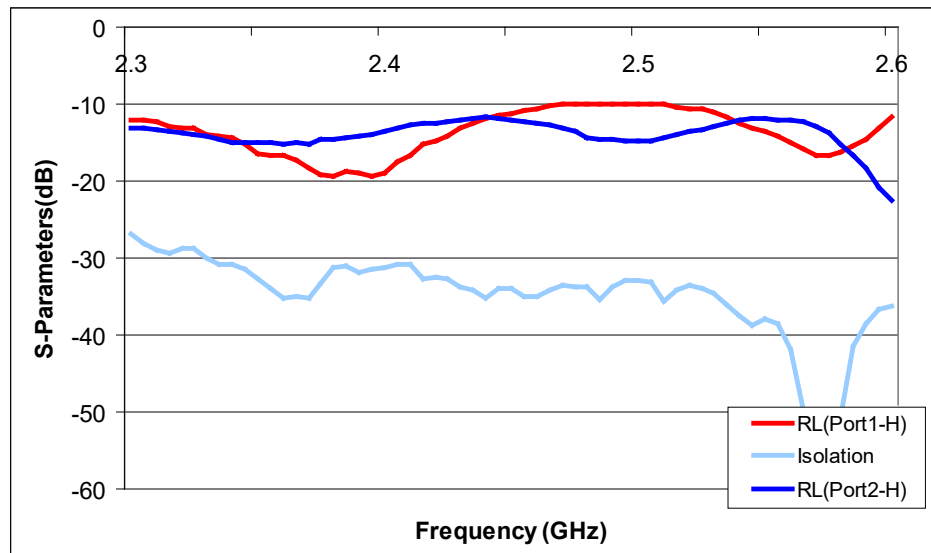

Antenna Element Specifications

Polar Plots (At 2.45 GHz)

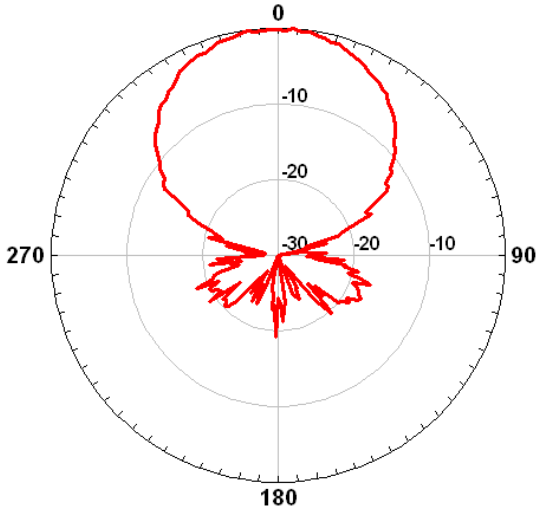

H-Pol Azimuth (Port 1 - H)

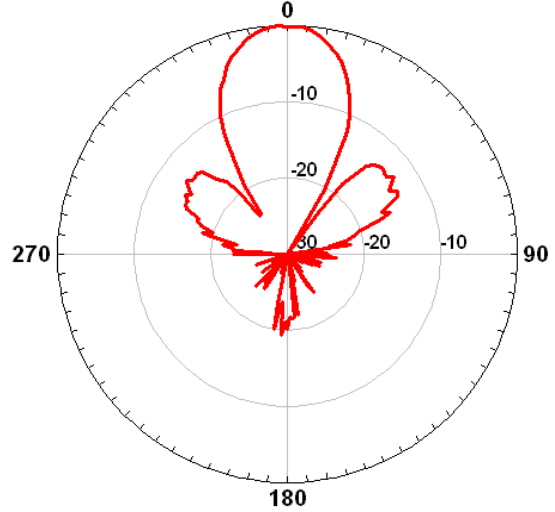

H-Pol Elevation (Port 1 - H)

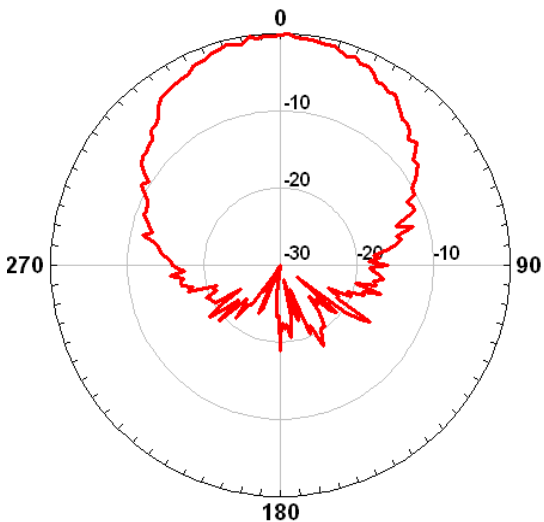

V-Pol Azimuth (Port 2 - V)

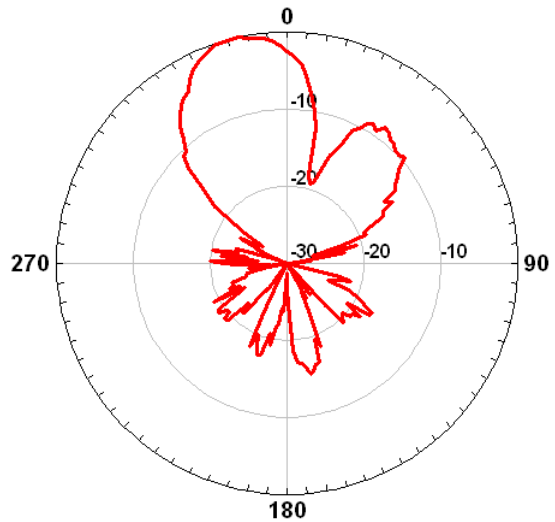

V-Pol Elevation (Port 2 - V)